

## Pour charpente bois

### Gamme 18-45

SC45NT080  
SL45NT170  
ACSP240  
ACSP310  
ACSP400  
ACSP480

### Gamme 17-47

SC47NT080  
SL47NT170  
ACS48240  
ACS48310  
ACS48400  
ACS48480

### SUSPENTES SUPER LONGUES

### SUSPENTES NT

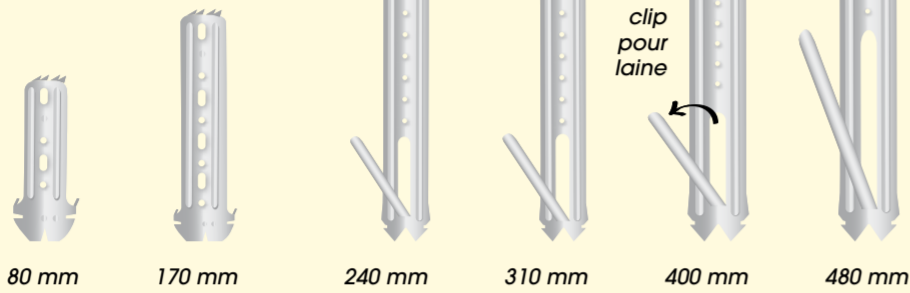

## PLAFOND

### GAMME COMMUNE

#### Suspente secable

SSEC0600  
SSEC1000

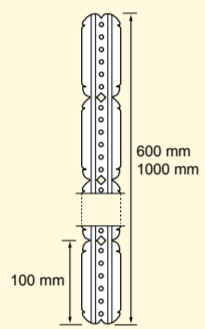

#### Suspentes rapides

APSR018030  
APSR030060  
APSR060100  
APSR080150  
APSR110200

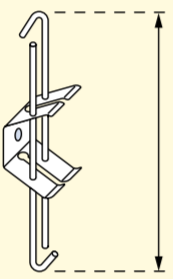

#### Cavalier Pivot 18/45

CAVALIER

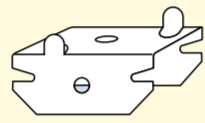

#### Attache Oméga

OMEGA

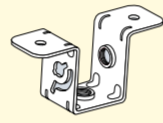

#### Cavalier Pivot 17/47

CAVALIERS

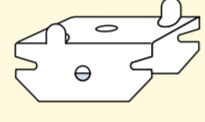

#### Attache articulée 3D

ATTACHE3D

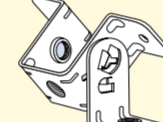

#### Cavalier Cavascope

CAVASCOPE

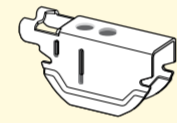

#### Coulisseau

COULISSEAU

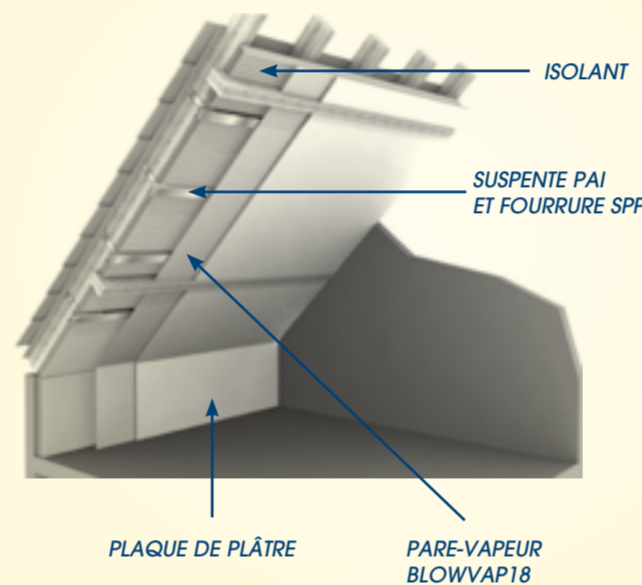
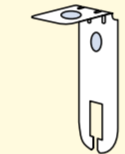

## Pour plancher béton

### HOURDIS BETON

#### Suspente HL72

ACSPHL72

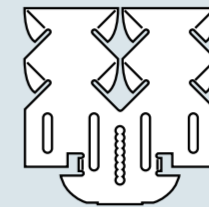

#### Suspente H50

ACSPH50

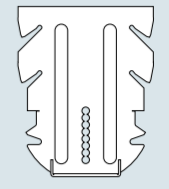

### HOURDIS LEGER

#### Suspente PHAR

ACSPHAR

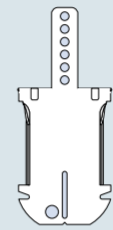

#### Suspente PHAST

ACSPHAST

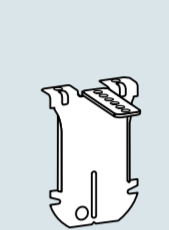

## Pour longue portée

#### Attache Omnifix

OMNIFIX

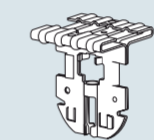

#### Crampon Omnifix

CRAMPON10M6

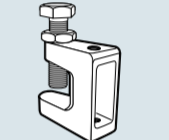

#### Eclisse Omnifix

ECLISSE70  
ECLISSE100

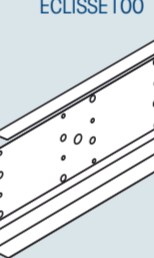

#### Embout Omnifix

EMBOUT

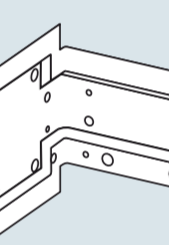

### Ossature primaire

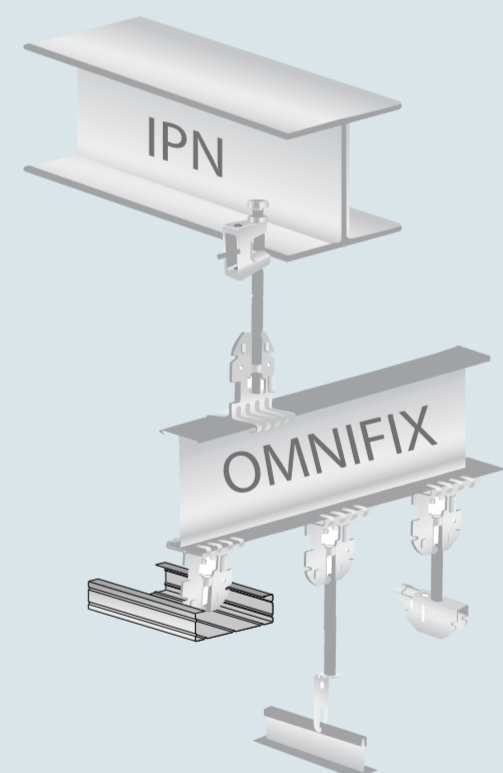

## Pour mur et doublage

#### Raccord 18-45

RACCORD

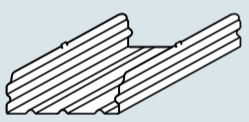

#### Raccord 17-47

RACCORDS

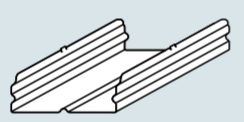

#### Raccord SB

RACCORDSB

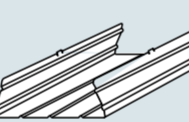

#### Rallonge ECLISCOPE

ECLISCOPEB/300

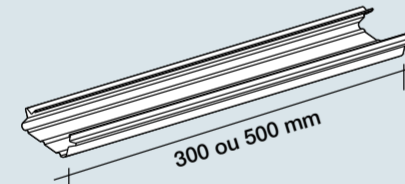

#### Appui intermédiaire

APPUIK60  
APPUIK90  
APPUIK130

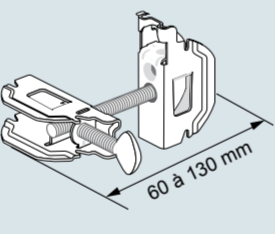

#### Platine Multifonctions FIXETIGE

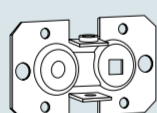

#### Cavalier CAVAFIX

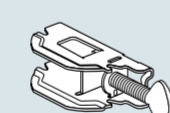

## DOUBLAGE

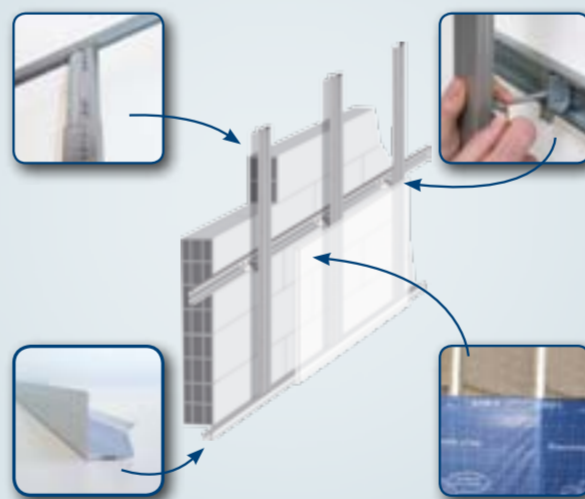

## Pour l'étanchéité

#### Pare-vapeur intérieur

BLOWVAP18

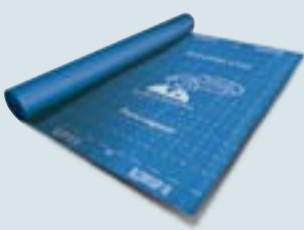

50 ml

#### Bandes résilientes

RESILIS20  
RESIRAIL45

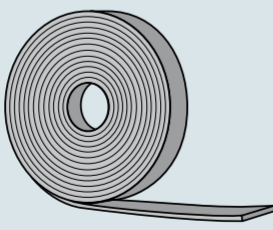

10 ml

#### Rail PVC pour pièces humides

RAILPVC5020  
RAILPVC6020  
RAILPVC7220  
RAILPVC12520

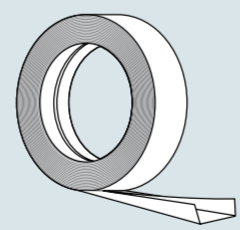

20 ml

## CLOISON

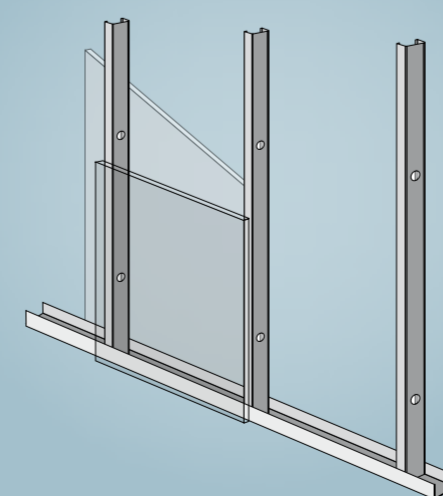
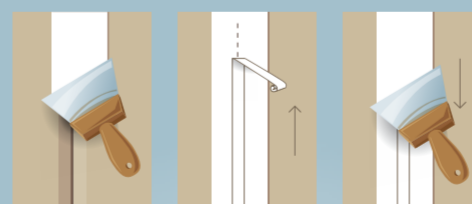

Respecter les prescriptions indiquées dans le DTU 25.41 « Ouvrages en plaques de plâtres »

## Pour joints de finition et renforts d'angle

#### Bande à joint papier

BJP020  
BJP150

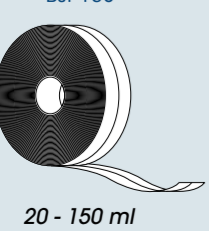

20 - 150 ml

#### Bande armée

BAT2  
BA30



12 - 30 ml

#### Bande à joint adhésive

BJA020  
BJA045  
BJA090  
BJA150



20 à 150 ml

#### Cornière métallique

CAMGA

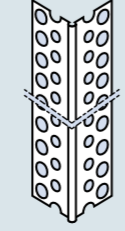

2500 mm

## Visserie & divers

#### Vis TTPC 25 à 140

VIS35025  
VIS35035  
VIS35045  
VIS38055  
VIS42070  
VIS42080  
VIS48090  
VIS48100  
VIS48110  
VIS48120  
VIS48130  
VIS48140

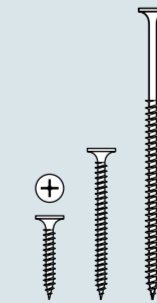

#### Tige filetée de 60 à 3000 mm

TIGFILO61000  
TIGFILO62000  
TIGFILO63000

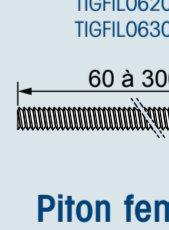

60 à 3000

#### Vis TRPF

VIS35013



#### Piton femelle

PITONFEME

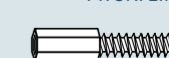

#### Feuillard perforé

APPFERFO



100 ml

#### Piton mâle

PITONMALE

